

**GT-TC041X-HXXX-LXA**

**G-SWITCH**

**Operating Force**  
A=160gf  
B=250gf

A=Base With Pilot  
N=Non Pilot

**Switch Height (mm)**  
H010=1.0mm

**Switch lifetime (Force)**  
L1=100,000 Cycles

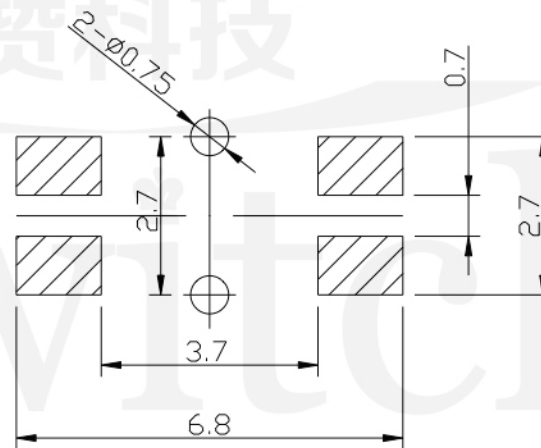
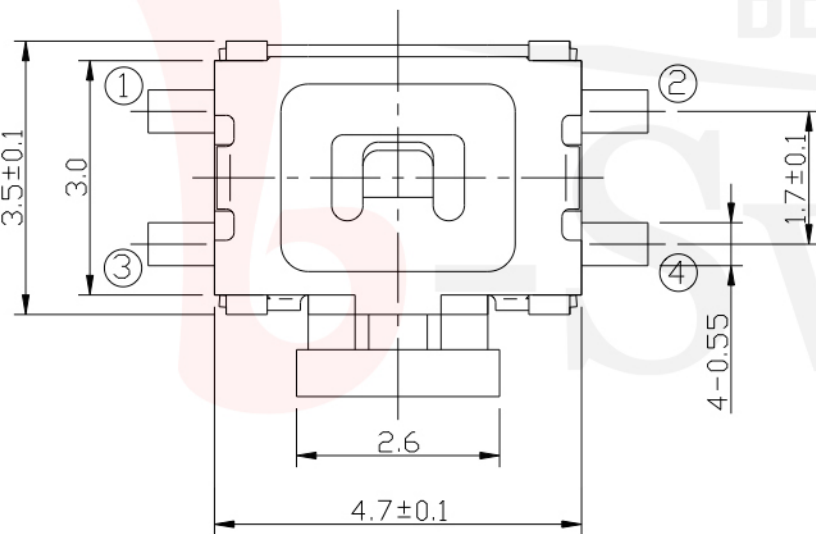

**P.C.B LAND DIMENSION**

**G-Switch Specification:**

Operating temperature range : -30°Cto+85°C  
 Rating : 50mA.12V DC  
 Insulation resistance : 100MΩ min.100V DC  
 Dielectric strength : 250V AC for 1 min  
 Contact resistance : 100m Ω max.  
 Travel:0.25±0.1mm

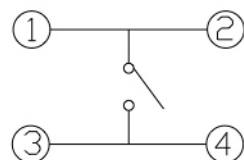

**CIRCUIT DIAGRAM**



**G-Switch Electronic (HongKong) CO.,Ltd.**

Unless otherwise specified, Tolerance:  
 X. ±0.30  
 X.x ±0.20  
 X.xx ±0.15  
 X.xxx ±0.10  
 Angles ±3°

DESIGN FengFengChen DATE 2019.05.29  
 CHECKED DATE  
 APPROVED DATE  
<http://www.dg-switch.com>  
 TEL:0769-82388879

Molde code:  
**GT-TC041X-HXXX-LXA**  
 REV.: X1 SCALE: 4:1 UNIT: mm  
 SIZE: A4 SHEET: 1/1

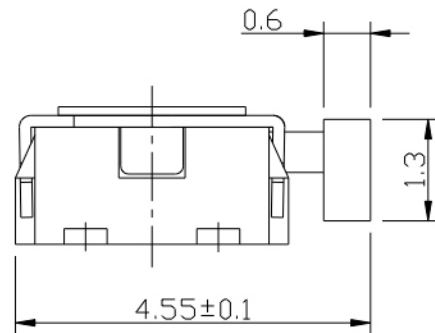
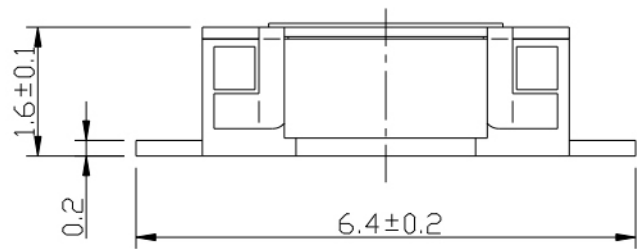

GT-TC041X-HXXX-LXN

G-SWITCH

Operating Force  
A=160gf  
B=250gf

A=Base With Pilot  
N=Non Pilot

Switch Height (mm)  
H010=1.0mm

Switch lifetime (Force)  
L1=100,000 Cycles

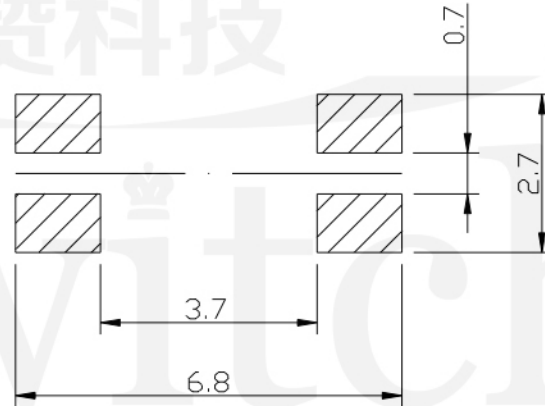
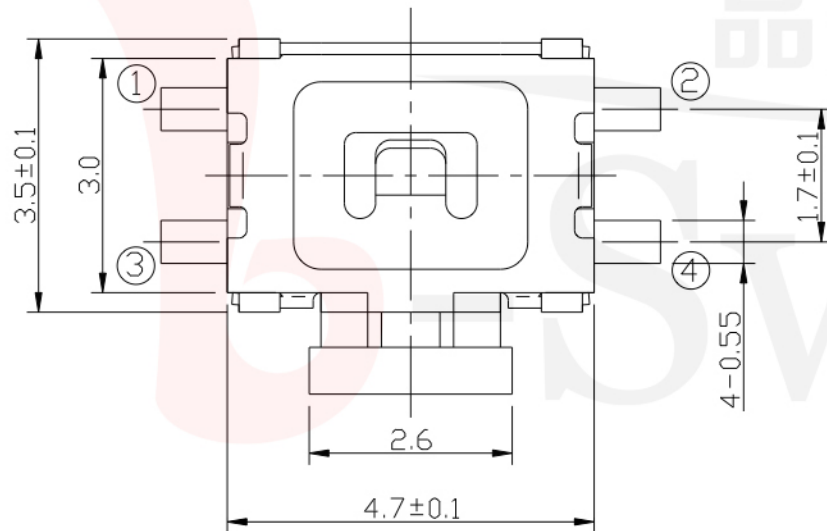

P.C.B LAND DIMENSION

**G-Switch Specification:**

Operating temperature range : -30°Cto+85°C  
Rating : 50mA.12V DC  
Insulation resistance : 100MΩ min.100V DC  
Dielectric strength : 250V AC for 1 min  
Contact resistance : 100m Ω max.  
Travel:0.25±0.1mm

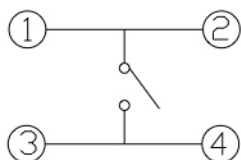

CIRCUIT DIAGRAM



	G-Switch Electronic (HongKong) CO.,Ltd.		
	DESIGN FengFengChen	DATE 2019.05.29	Molde code:
Unless otherwise specified, Tolerance:	CHECKED	DATE	GT-TC041X-HXXX-LXN
X. ±0.30	APPROVED	DATE	
X.x ±0.20	http://www.dg-switch.com		REV.: X1
X.xx ±0.15	TEL:0769-82388879		SCALE: 4:1
X.xxx ±0.10			UNIT: mm
Angles ±3°			SIZE: A4
			SHEET: 1/1