

MATING HEIGHT	PLUG (H.mm)	SOCKET (H.mm)
3.0	0.8	2.2
3.5	1.3	2.2
4.0	1.0	3.0
4.5	1.0	3.5
5.0	1.0	4.0
5.5	1.0	4.5
6.0	2.0	4.0
6.5	2.0	4.5



GT-B0501 M S V XX -XX X XX 01

- G-Switch**
- Series No**
- M-Male**
- Termipoint**
S-SMT
- Angle**
V-180°
- Terminal Plating**
11-All G/F
- Housing Colour**
B-Black
- Pin Q' PY**
08~100
- Height**
08-0.80mm, F=1.60
10-1.00mm, F=1.90
13-1.30mm, F=1.60
20-2.00mm, F=1.90

G-Switch Specification:

1. Current rated: 0.5A AC/DC
2. Voltage rating: 50V AC/DC
3. Withstanding voltage: 500V AC
4. Contact resistance: 40mΩ Max.
5. Insulation resistance: 800MΩ min
6. Durability cycle: 30 Cycles
7. Removal force: 0.03kgf/Pin min
8. Operating temperature range: -45°C ~ +105°C

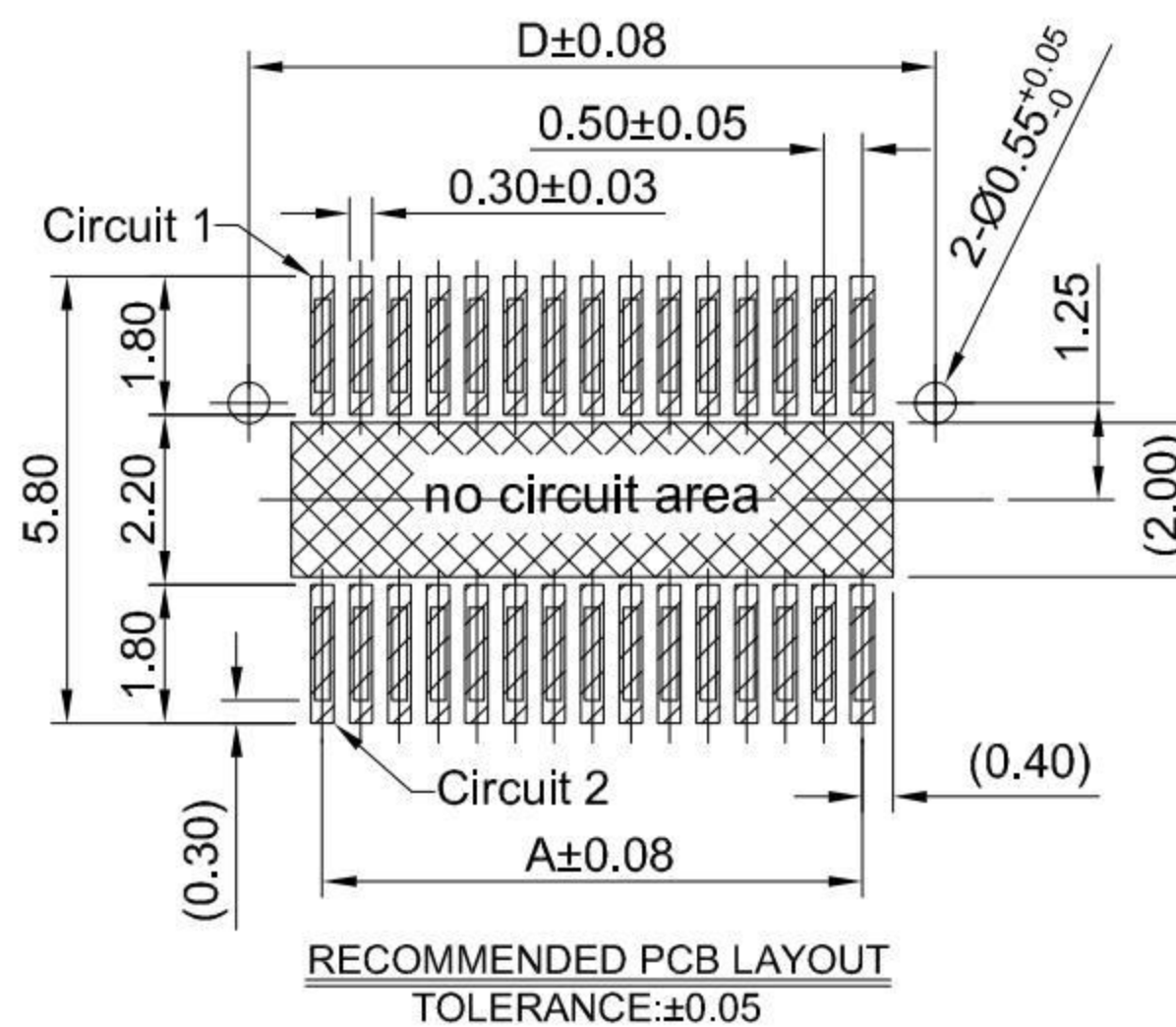
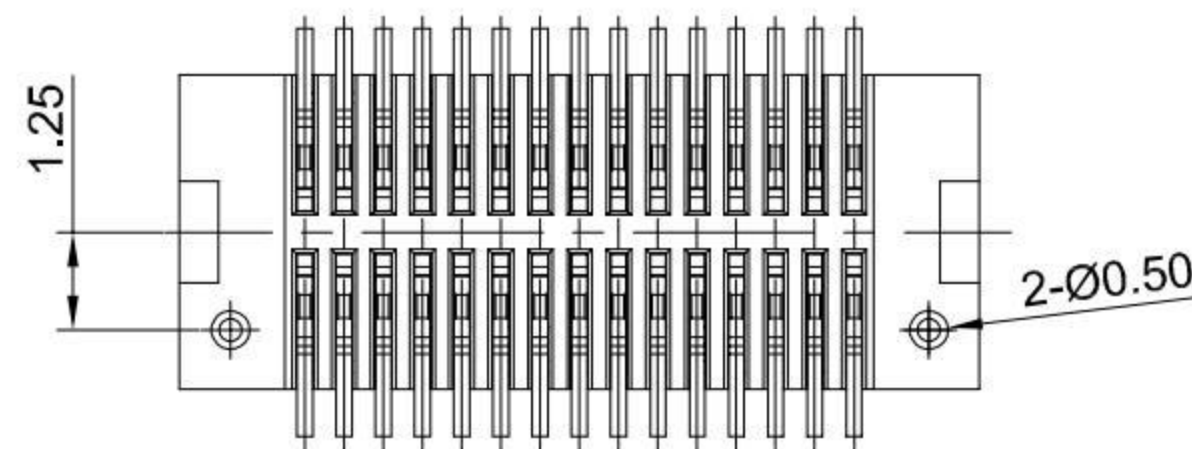
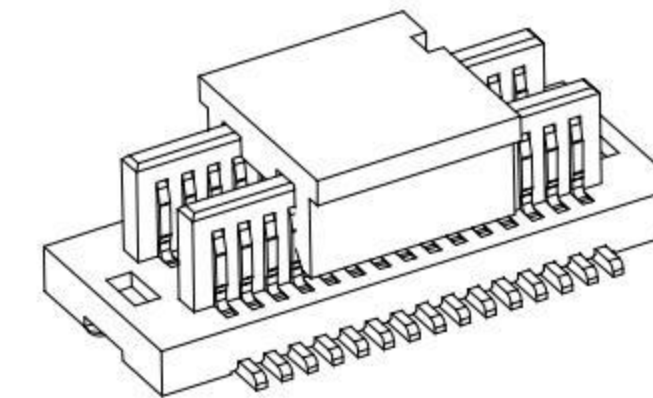
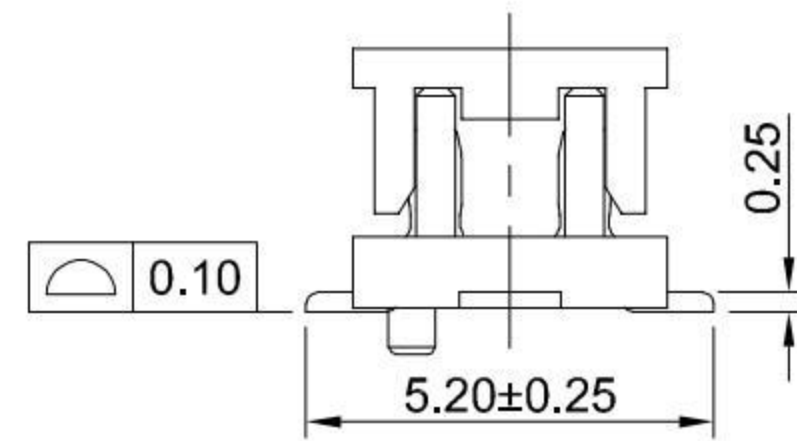
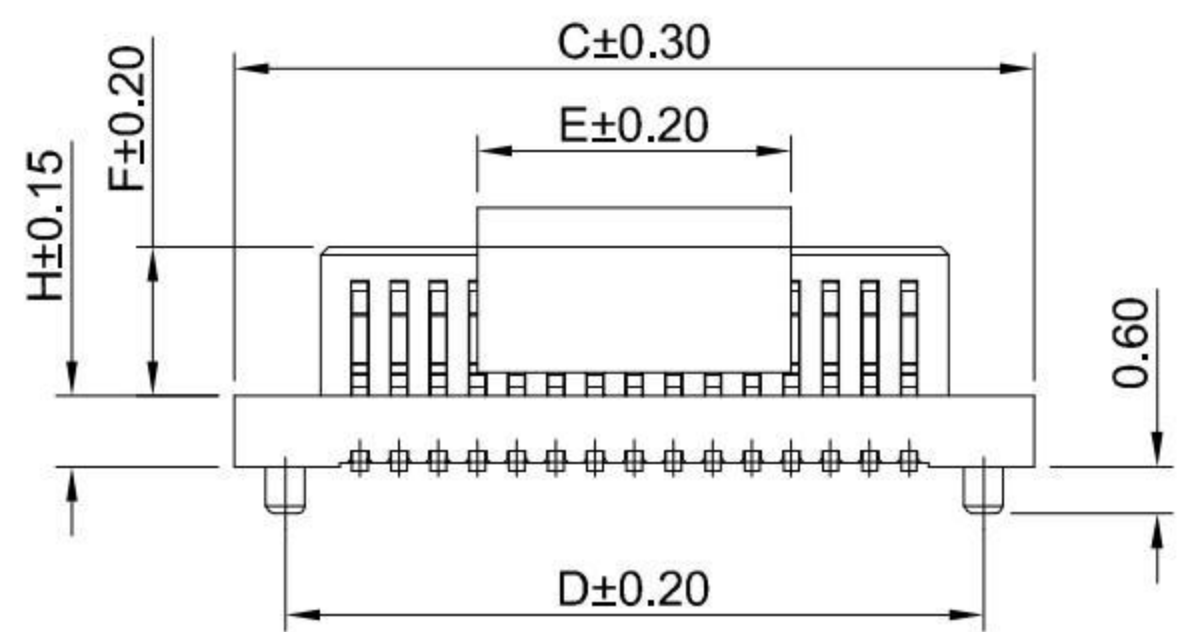

Ordering Information:

Circuit	Dimensions(mm)					Circuit	Dimensions(mm)				
	A	B	C	D	E		A	B	C	D	E
08	1.50	2.50	4.70	3.40	4.00	40	9.50	10.50	12.70	11.40	8.00
10	2.00	3.00	5.20	3.90		42	10.00	11.00	13.20	11.90	
12	2.50	3.50	5.70	4.40		44	10.50	11.50	13.70	12.40	
14	3.00	4.00	6.20	4.90		46	11.00	12.00	14.20	12.90	
16	3.50	4.50	6.70	5.40		50	12.00	13.00	15.20	13.90	
18	4.00	5.00	7.20	5.90		52	12.50	13.50	15.70	14.40	
20	4.50	5.50	7.70	6.40		54	13.00	14.00	16.20	14.90	
22	5.00	6.00	8.20	6.90		56	13.50	14.50	16.70	15.40	
24	5.50	6.50	8.70	7.40		60	14.50	15.50	17.70	16.40	
26	6.00	7.00	9.20	7.90		66	17.00	16.00	19.20	17.90	
28	6.50	7.50	9.70	8.40		70	18.00	17.00	20.20	18.90	
30	7.00	8.00	10.20	8.90		80	20.50	19.50	22.70	21.40	
32	7.50	8.50	10.70	9.40		90	23.00	22.00	25.20	23.90	
34	8.00	9.00	11.20	9.90		100	25.50	24.50	27.70	26.40	
36	8.50	9.50	11.70	10.40		---	---	---	---	---	



SCALE: 1:1 UNIT: mm
SIZE: A4

Unless otherwise General Tolerance:
X ±0.40
X.x ±0.30
X.xx ±0.20
X* ±5°
X.x° ±3°

Title: BTB 0.50 Pitch 180° Dual Rows SMT Type Mate Connector

Molde Code: GT-B0501MSVXX-XXXXX01

DRAWN	CHECKED	APPROVED	DATE
Hu	Chen	Chen	2022.12.28



REV: A0 SHEET: 1/2

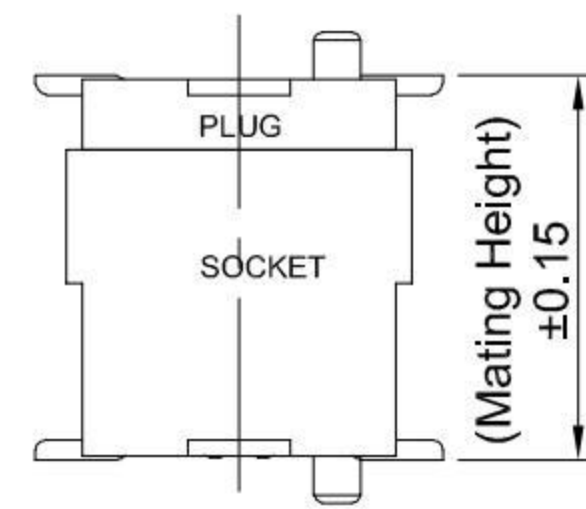
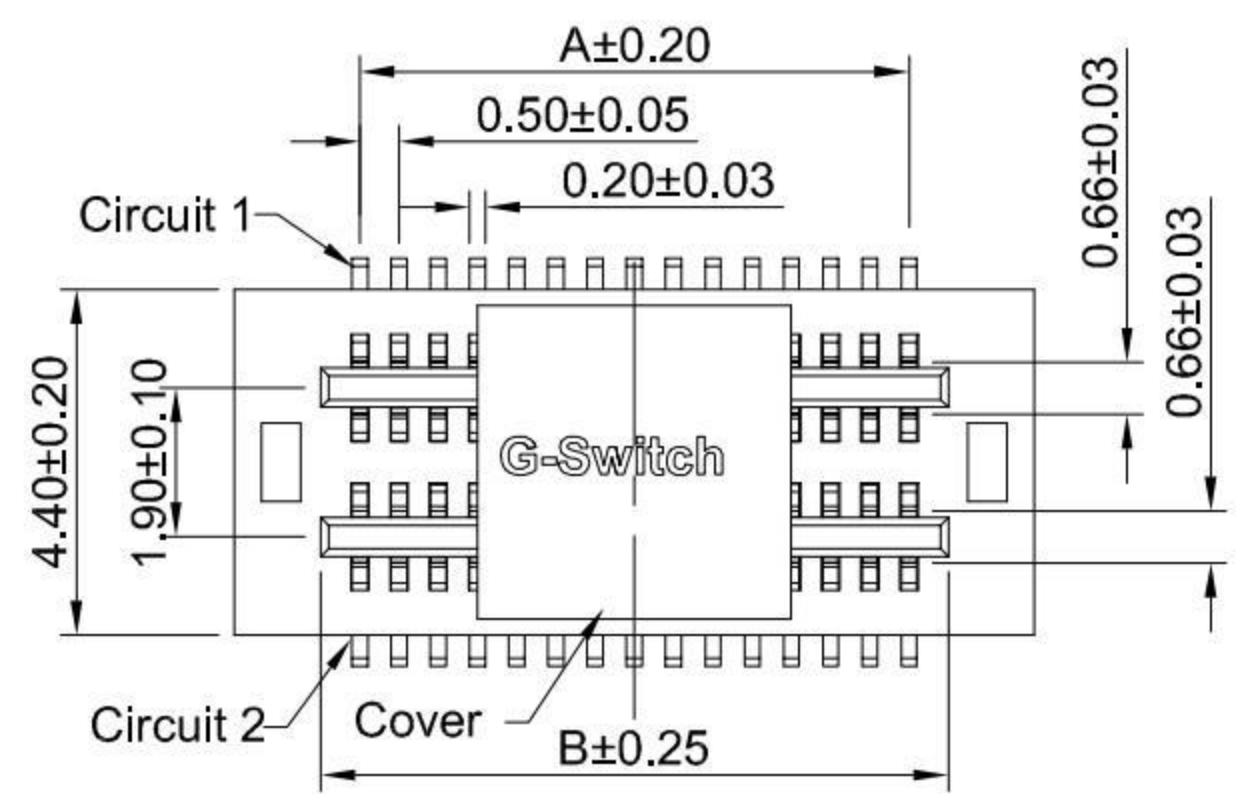

MATING HEIGHT	PLUG (H.mm)	SOCKET (H.mm)
7.0	4.0	3.0
7.5	4.0	3.5
8.0	4.0	4.0
8.5	4.0	4.5



GT-B0501 M S V XX -XX X XX 01

- G-Switch**
- Series No**
- M-Male**
- Termpoint**
S-SMT
- Angle**
V-180°
- Terminal Plating**
11-All G/F
- Housing Colour**
B-Black
- Pin Q' PY**
08~100
- Height**
40-4.00mm

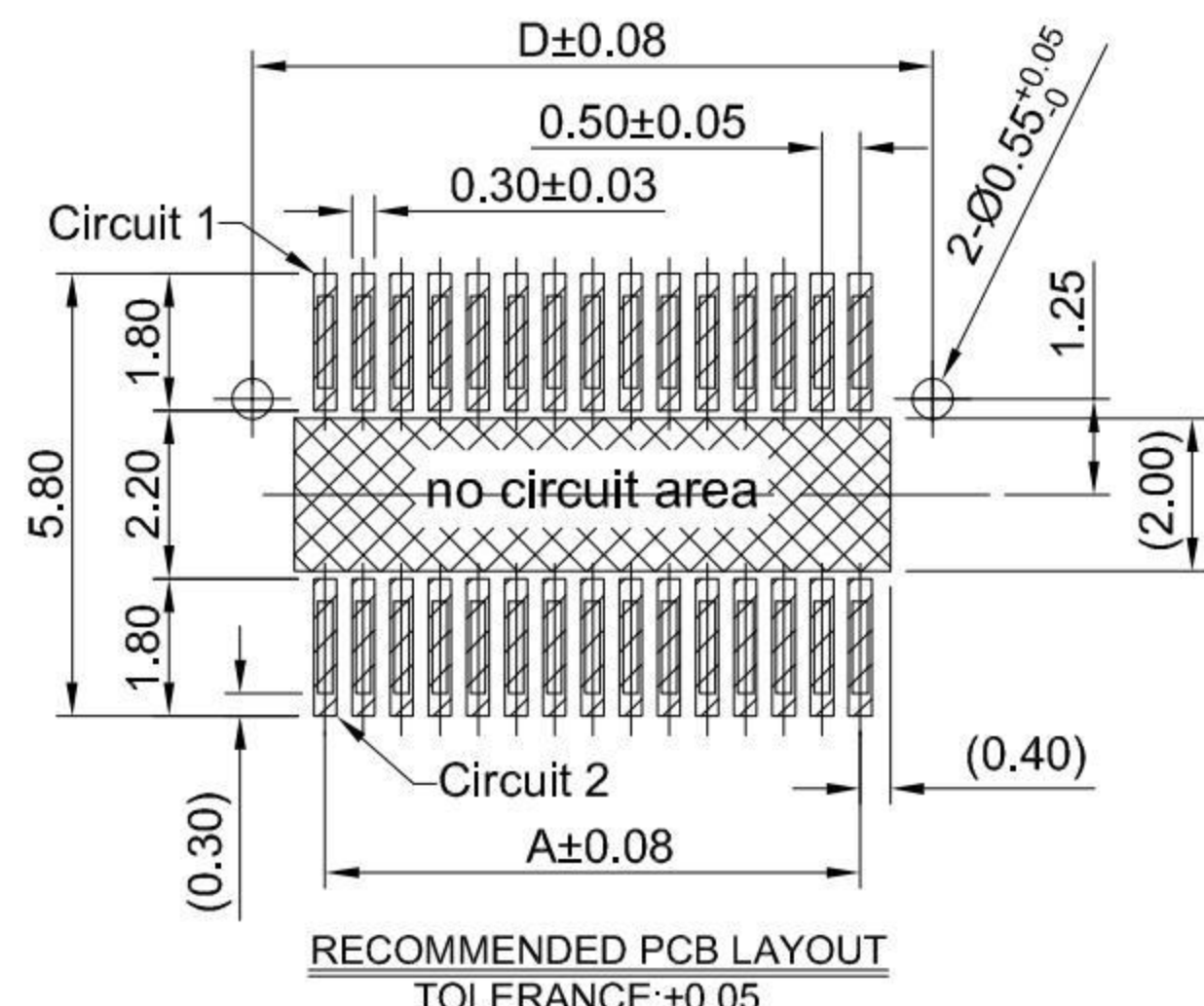
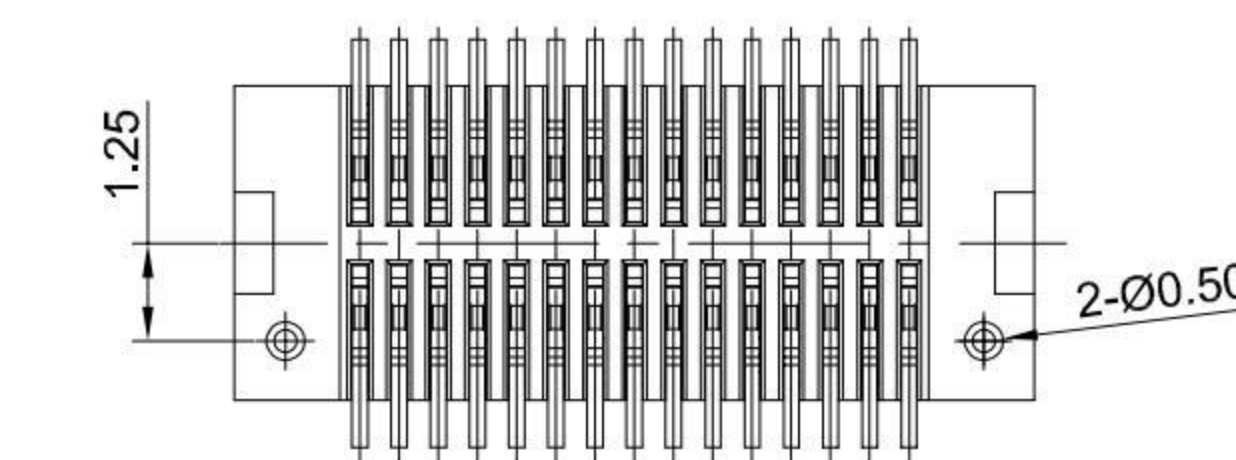
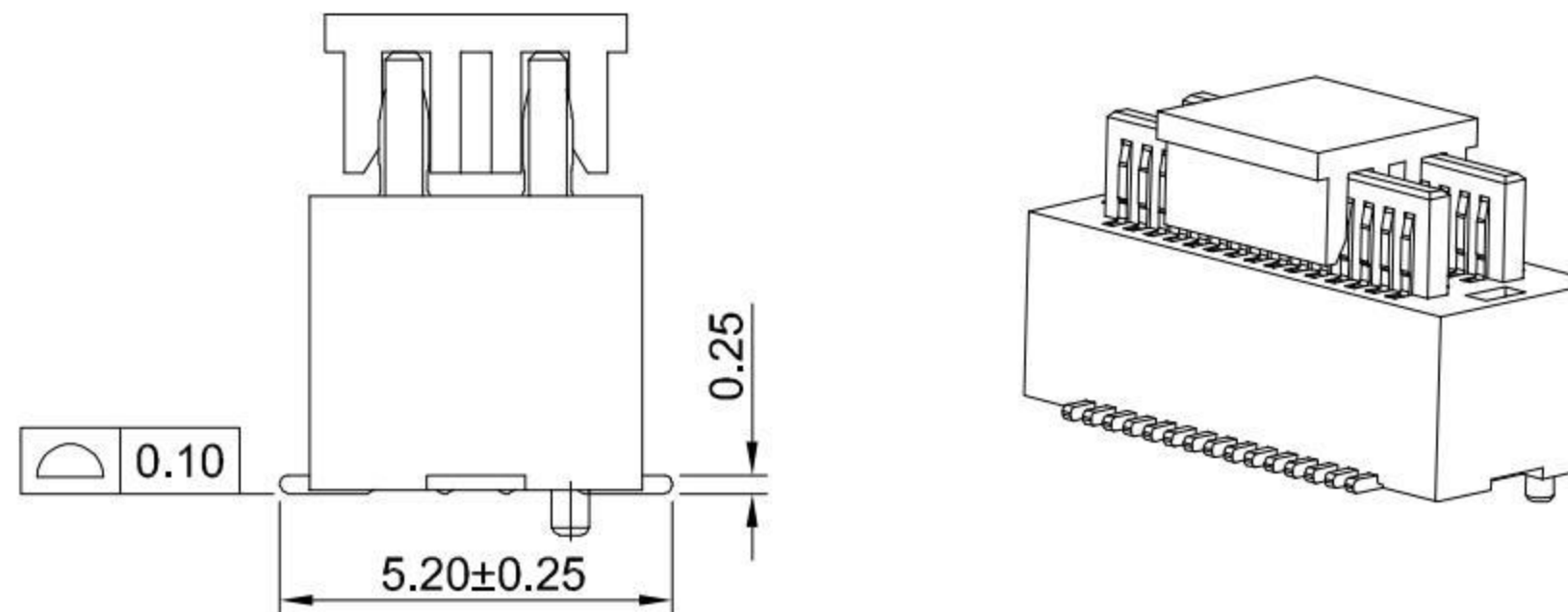
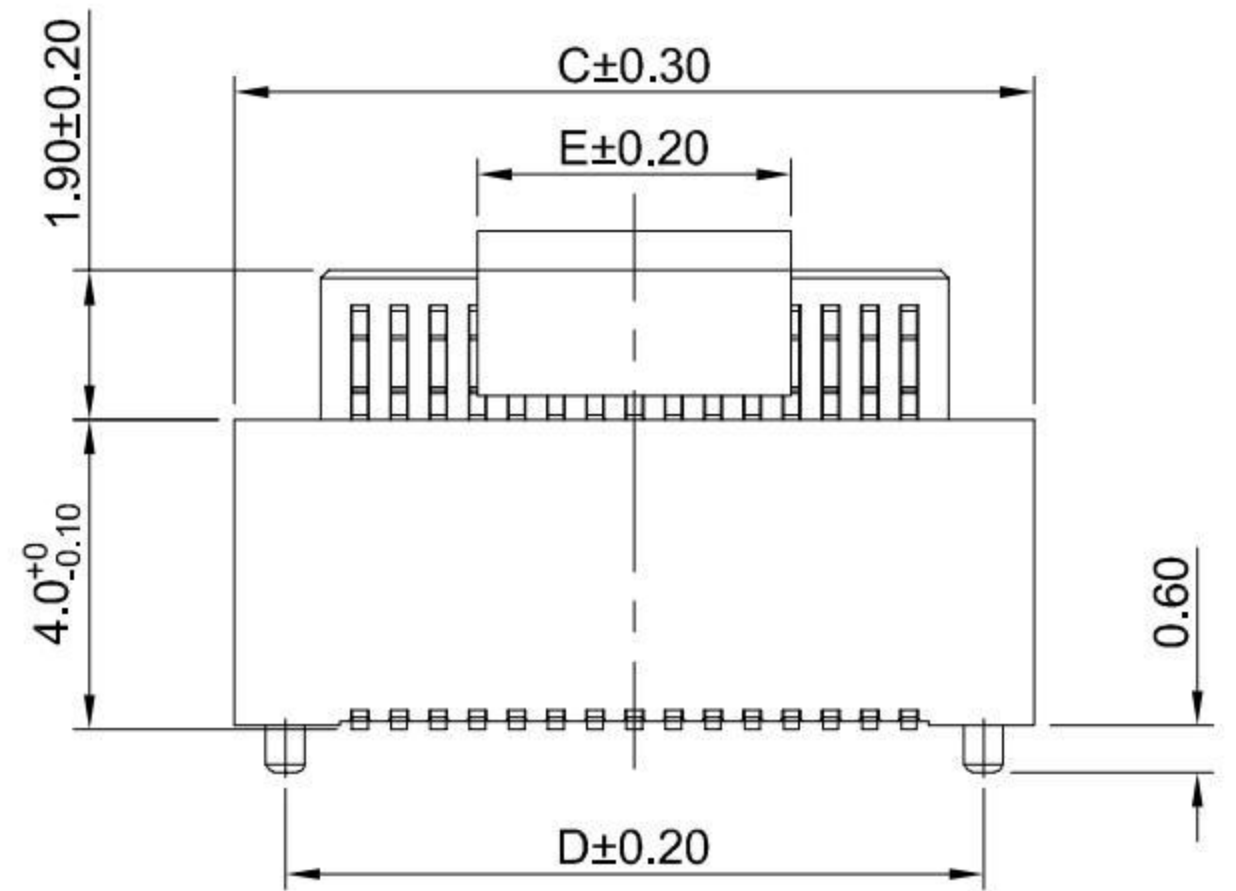

- G-Switch Specification:**
- Current rated: 0.5A AC/DC
 - Voltage rating: 50V AC/DC
 - Withstanding voltage: 500V AC
 - Contact resistance: 40mΩ Max.
 - Insulation resistance: 800MΩ min
 - Durability cycle: 30 Cycles
 - Removal force: 0.03kgf/Pin min
 - Operating temperature range: -45°C ~ +105°C

Ordering Information:

Circuit	Dimensions(mm)					Circuit	Dimensions(mm)				
	A	B	C	D	E		A	B	C	D	E
08	1.50	2.50	4.70	3.40	4.00	40	9.50	10.50	12.70	11.40	8.00
10	2.00	3.00	5.20	3.90		42	10.00	11.00	13.20	11.90	
12	2.50	3.50	5.70	4.40		44	10.50	11.50	13.70	12.40	
14	3.00	4.00	6.20	4.90		46	11.00	12.00	14.20	12.90	
16	3.50	4.50	6.70	5.40		50	12.00	13.00	15.20	13.90	
18	4.00	5.00	7.20	5.90		52	12.50	13.50	15.70	14.40	
20	4.50	5.50	7.70	6.40		54	13.00	14.00	16.20	14.90	
22	5.00	6.00	8.20	6.90		56	13.50	14.50	16.70	15.40	
24	5.50	6.50	8.70	7.40		60	14.50	15.50	17.70	16.40	
26	6.00	7.00	9.20	7.90		66	17.00	16.00	19.20	17.90	
28	6.50	7.50	9.70	8.40		70	18.00	17.00	20.20	18.90	
30	7.00	8.00	10.20	8.90		80	20.50	19.50	22.70	21.40	
32	7.50	8.50	10.70	9.40		90	23.00	22.00	25.20	23.90	
34	8.00	9.00	11.20	9.90		100	25.50	24.50	27.70	26.40	
36	8.50	9.50	11.70	10.40		---	---	---	---	---	



SCALE: 1:1 UNIT: mm
 SIZE: A4
 Unless otherwise General Tolerance:
 X ±0.40
 X.x ±0.30
 X.xx ±0.20
 X° ±5°
 X.x° ±3°

Title: BTB 0.50 Pitch 180° Dual Rows SMT Type Mate Connector
 Molde Code: GT-B0501MSV40-XXXXX01
 DRAWN: Hu CHECKED: Chen APPROVED: Chen DATE: 2022.12.28



REV: A0 SHEET: 2/2